

PRELUDE 24 TLX

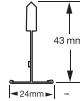

Exposed 24 mm grid system (nominal).

Universal Main Runners Prelude 24 Peakform and Superlock Clip (bulb-to-bulb connection)

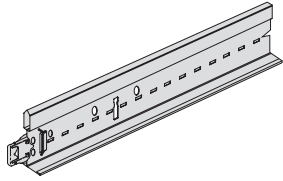

Item Nr.	Dimensions		Content / Carton		Weight / Carton kg	Cartons / Pallet
	Length (mm)	Height (mm)	pcs	lm		
BP 31 40 32 A ⁽¹⁾	3600	43	20	72,00	21,00	30
BP 31 41 33 B ⁽¹⁾	3750	43	20	75,00	21,90	30
BP 31 43 33 B	3375	43	20	67,50	20,00	30
BP 31 42 32	3000	43	20	60,00	17,50	30

Cross Tees Prelude 24 TLX (Hook system, butt cut)

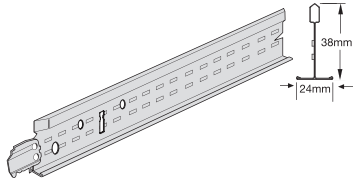

Cross Tees slotted

BP 13 31 31 ⁽¹⁾	1250	38	60	75,00	18,90	72
BP 13 30 31 ^{(1) (2)}	1200	38	60	72,00	18,10	72
BP 13 60 31	600	38	60	36,00	9,10	144

BP 13 10 32	1875	38	30	56,20	17,80	20
BP 13 34 32	1800	38	30	54,00	17,10	20
BP 13 50 32	1724	38	30	51,70	16,50	20
BP 13 36 32	1500	38	30	45,00	14,50	20
BP 13 33 31	1350	38	60	81,00	17,20	20
BP 13 32 32	1000	38	60	60,00	19,40	72

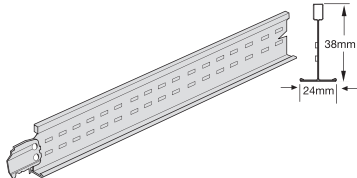

Cross Tees unslotted

BP 13 18 31	900	38	60	54,00	13,60	72
BP 13 16 31	750	38	60	45,00	11,40	72
BP 13 21 31 ⁽¹⁾	625	38	60	37,50	9,50	144
BP 13 20 31 ^{(1) (2)}	600	38	60	36,00	9,10	144

BP 13 23 31	675	38	60	40,50	8,70	144
BP 13 22 32	500	38	60	30,00	9,70	80

Section Drawings

Universal Main Runners Prelude 24

Length	78,125	156,25	21 x 156,25	156,25	78,125
3750	78,125	156,25	21 x 156,25	156,25	78,125
3600	50	100	33 x 100	100	50
3375	337,5	675	2 x 675	675	337,5
3000	50	100	27 x 100	100	50

Cross Tee Prelude 24 TLX

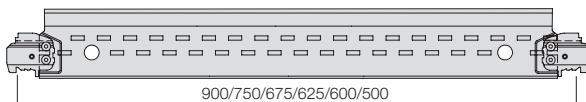

Cross Tee Prelude 24 TLX

Length	312,5	4 x 312,5	312,5
1875	312,5	4 x 312,5	312,5
1800	300	4 x 300	300
1724	262	4 x 300	262
1500	150	350 / 2 x 250 / 350	150
1350	337,5	2 x 337,5	337,5
1250	312,5	2 x 312,5	312,5
1200	300	2 x 300	300
1000	250	2 x 250	250

(1) Colours available : Carrara (CA), Platinum (PN), Black (BK), RAL 9006 (SG), Brass (BS), Chrome (CE) and White RAL 9010 (WR).

(2) Also available in Black (NG), Brown (MR) and Beige (BJ).

Cross tee alignment is achieved by locating the tees to the right-hand side of the adjoining section.

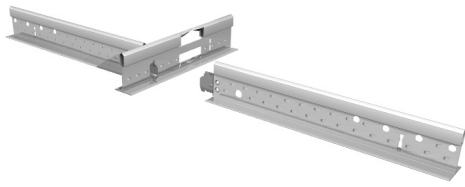

PRELUDE 24 TLX

System Drawing (module 1200 x 600 mm)

Standard lay-in installation of 24 mm exposed suspension system using Board or Tegular edge tiles.

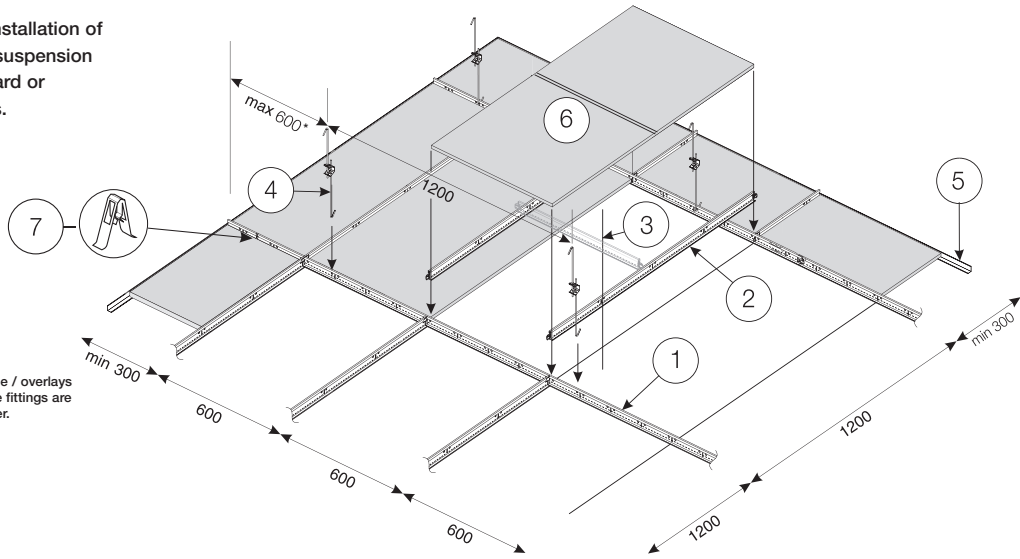

*reduce to 450 if heavy tile / overlays are used or heavy service fittings are located near the perimeter.

Quantities required per 1m ² (no waste included)							
6 Tile	Main Runner centres	Hanger centres	1 Main Runner	2 Cross Tee 1200 mm	3 Cross Tee 600 mm	4 Hanger	7 Universal Retaining Clip
1200 x 600 mm 1,39 pcs	1200 mm	1200 mm	0,84 lm	1,67 lm	-	0,70 pcs	5,56 pcs
	600 mm	1200 mm	1,67 lm	-	0,84 lm	1,40 pcs	5,56 pcs
600 x 600 mm 2,78 pcs	1200 mm	1200 mm	0,84 lm	1,67 lm	0,84 lm	0,70 pcs	5,56 pcs
	600 mm	1200 mm	1,67 lm	-	1,67 lm	1,40 pcs	5,56 pcs

5 Perimeter Trim approx. 0,70 lm/m²

The chart is for general guidance only.

Grid Load Capacities

Prelude 24 TLX System

The following table gives the maximum permitted hanger distance (mm) along the Peakform Main Runner (BP 31 40 32 A) for the tile weights and Main Runner spacings noted.

Tile weight	Distance between Main Runners		
	1800 mm TLX Cross Tee BP 13 34 32	1200 mm TLX Cross Tee BP 13 30 31	600mm TLX Cross Tee BP 13 20 31
2,5 kg/m ²	1650	1900	2100
3,0 kg/m ²	1600	1800	2100
3,5 kg/m ²	1500	1750	2100
4,0 kg/m ²	1450	1700	2100
5,0 kg/m ²	1350	1600	2000
5,5 kg/m ²	1350	1550	1950
6,0 kg/m ²	1250	1500	1900
7,0 kg/m ²	-	1450	1800
8,5 kg/m ²	-	1300	1700
10,5 kg/m ²	-	1200	1600
13,0 kg/m ²	-	1050	1500

- The above table values may be influenced by either bending moment or deflection. For other deflection limits (L/300, L/360, L/400), please contact your **Armstrong Technical Sales**.
- Load values determined from laboratory tests in accordance with EN 13964 : 2004.
- Applicable for 600 x 600 mm tiles and assuming that the maximum deflection of the grid is L/500 but not greater than 4 mm (L = span).
- No other applied loads such as luminaires, air diffusers, smoke detectors, sprinklers, hanging signs etc. are permitted.**
- No overlays such as mineral wool or fibre glass quilts, as may be required for enhanced acoustic, fire or thermal performance, are permitted unless their full weight is established and included, together with the weight of the tile, within the appropriate weight groups.

Availability of products may vary according to location. Please contact our **Armstrong Technical Sales** for further details.

CENTRAL EUROPE NORTH (DK/EE/FIN/IS/LT/LV/N/PL/S)

Latvia : www.armstrong.lv
Lithuania : www.armstrong.lt
Norway : www.armstrong.no
Poland : www.armstrong.pl
Sweden : www.armstrong.se

CENTRAL EUROPE SOUTH

(AL/BA/BG/CZ/HR/HU/KO/MD/ME/MK/RO/RS/SK/SI)

Czech Republic : www.armstrong.cz
Hungary : www.armstrong.co.hu
Romania : www.armstrong.ro
Serbia : www.armstrong.rs
Slovakia : www.armstrong.sk
Slovenia : www.armstrong.si
www.armstrong.eu

